PREFACE

Dear users:

Welcome to purchase and use our products and thank you for your confidence in our company's products!

It has been our target to make the international-level advanced surveying instrument since our company was established. All our surveying products are good-looking, reliable and multifunctional. Please read this operational manual carefully before usage of the instrument.

If you have any questions or suggestions, please do not hesitate to contact with the nearest sales point. We will do our best to serve you.

(In order to keep the instrument in good condition, we suggest that you should maintain it once annually at the sales point.)

The rights for revising technology and product specification are reserved by manufacturer and do not inform in advance.

CONTENTS

1. FEATURES	1
2. PREPARATIONS	2
2.1 Precautions	2
2.2 Parts	3
2.3 Unpacking and Storage	4
2.4 Battery and Charger	4
2.5 Assemble and Disassemble the Basal Stump	5
3. KEYBOARD AND PANEL	
3.1 Keyboard	6
3.2 Panel	6
3.3. Display Information	
4. INITIAL SETTING	8
4.1 Setting Items	8
4.2 Setting Method	8
5. PREPARATION FOR SURVEY	10
5.1 Centering and Leveling	10
5.2 Eyepiece Adjustment and Object Sighting	11
5.3 Power On or Off	12
5.4 Vertical Index Zero Setting (V 0SET)	12
6. BASIC SURVEY	14
6.1 Observation from Normal/Reversed Position	14
6.2 Horizontal Angle “0” Setting (0 SET)	14
6.3 Horizontal and Vertical Angle Measurement	14
6.4 Lock and Unlock Horizontal Angle (HOLD)	15
6.5 Quadrant Sound of Horizontal Angle Setting	15
6.6 Vertical Angle “0” Setting	15
6.7 Measure Zenith Distance and Vertical Angle	17
6.8 Slope Percentage	17
6.9 Repeat Angle Measure	18
6.10 Export Angle	19
6.11 Save Angle	19
6.12 Measure Distance with Stadia	20
7. MEMORY	21
7.1 Examine Instrument’s Serial Number	21
7.2 Examine Angle Data in Memory	21
7.3 Clear Angle Data in Memory	21
7.4 Transmit Data in Memory to Serial-port	
8. CONNECTION WITH CONTROLLER	23
9. INSPECTION AND ADJUSTMENT	24
9.1 Plate Vial	24
9.2 Circular Vial	24
9.3 Inclination of Reticle	24
9.5 Automatic Compensation for Vertical Index Difference	25

9.6 Vertical Index Difference (I Angle) and Set Vertical Index Zero	26
9.7 Optical Plummet	26
9.8 Other Adjustment.....	27
10. SPECIFICATIONS.....	28
11. COMMON MISTAKE.....	30
12. ACCESSORIES.....	31

1. FEATURES

Electronic theodolites of DT Series are designed by our company according to the concept of reasonable structure, smart appearance, reliable performance, various functions and easy operation. Not only easy to realize all functions, but also it has the features below:

Able to Connect with Electronic Controller

Able to connect with most of the electronic controllers on the market to complete field data collection automatically.

Easy to Operate Key-press

It only has 6 keys which can realize all measure functions and can show distance data from range finder on monitor.

Can operate in dark place

Telescope's crosshairs and screen are equipped with illumination resource so that you can operate it in dark place.

2. PREPARATIONS

2.1 Precautions

- (1) Avoid aiming the objective lens directly at the sun. When performing a measurement under sunshine, attach the filter to the objective lens.
- (2) Avoid storage or usage at extremely high or low temperature. Avoid subjecting it to rapid changes of temperature (refer to working temperature range).
- (3) Put into the carrying case for storage and place in a dry area when it isn't used, do not subject to vibrating, dust or high humidity.
- (4) When the storage temperature and usage temperature is widely different, left the instrument in the case until it adapt to the surrounding temperature.
- (5) When not in use for long period, disassemble battery from ET and recharge the battery once per month.
- (6) Put the instrument into its case when transport. Make sure to keep it from squeeze, clash and shake. Had better put soft pad around the case during line-haul.
- (7) Be sure to secure the instrument with one hand when mounting or removing from the tripod.
- (8) When the exposed optical parts need to be cleaned, clean them with degreased cotton or lens-head paper, not with other things.
- (9) Be sure to clean the plastic parts and organic glass with water-soaked cloth, rather than chemical reagent.
- (10) When the measure is finished, clean the surface of your instrument with woolen cloth or fur brush. If it is wetted, never turn it on. Put it in the ventilation place for a period of time and rub it dry with clean cloth.
- (11) Before operation, carefully inspect the power, functions and indexes of the instrument, initial setting and correction parameters.
- (12) Do not disassemble the instrument by yourself, even if a malfunction is found, unless you are a professional.

2.2 Parts

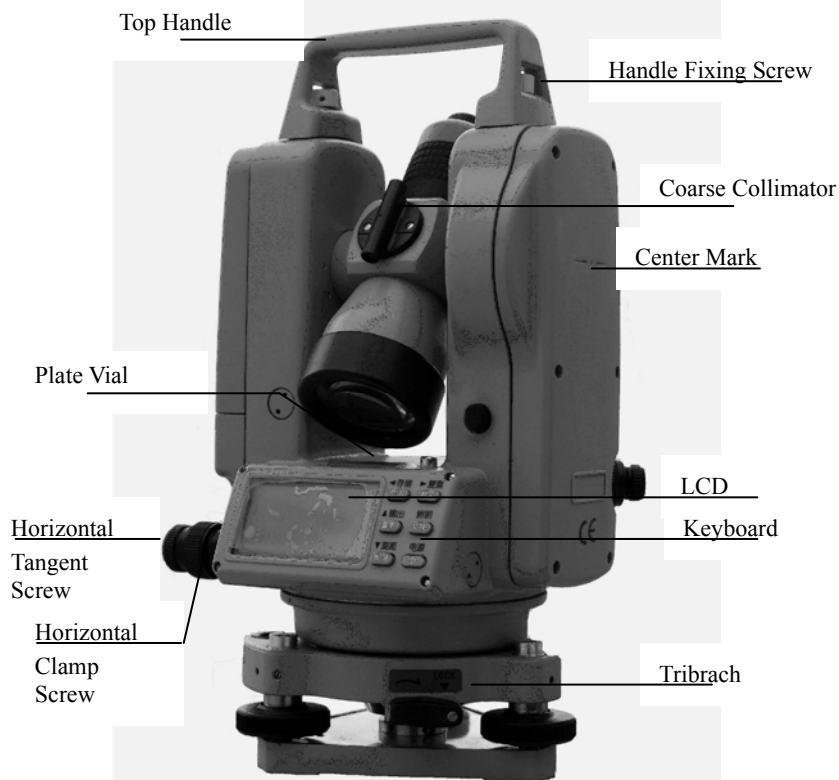
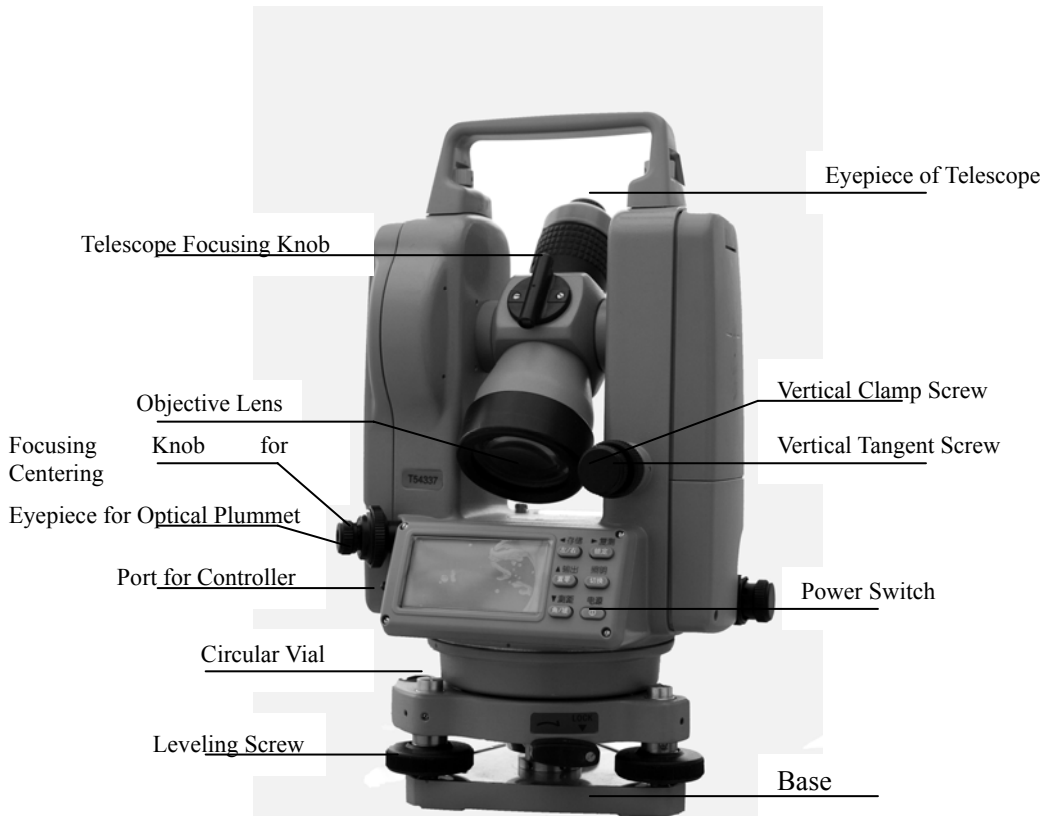

2.3 Unpacking and Storage

Unpacking

Gently lay down the carrying case and set its cover upward, unlatch and open the case. Then, take the instrument out of the case.

Storage

Set the telescope close to horizontal or vertical, and lightly tighten the telescope clamp screw. Align the white dot; place the instrument into the case with the white dot towards you. Close the case lid and lock the latch.

2.4 Battery and Charger





Assemble and Unassemble Battery

(1) Press the top button of the battery box to take off the battery box.

(2) Insert the bottom edge of the battery into the slot on the standard cover, and put the top button of the battery into the cover until it clicks.

Battery Information

Full battery can last for 8 to 10 hours continuously. The symbol “ ” in the lower right corner of the screen displays power consumption message. Power consumption is as follows:

-  and  indicate that energy is abundant.
-  indicates there is a little energy left, and ready to replace or recharge it.
-  twinkling indicates it will turn off in few minutes due to lack of energy, so stop operating and change battery ASAP.

Charging Battery

Please use special charger (10A) to recharge battery in instrument which is 10A, NiMH rechargeable one. Insert the battery charger into the power source with 220V, then red light lights. Take off the on-board battery from the main body and connect the plug of the charger to charge jack on the battery. The indicating lamp is red indicates the battery is recharging and it turns green in 6 hours means charge completes. Then remove the plug from the charge jack.

Warning: if the battery is placed improperly, it may cause explosion. Please deal with used battery in the light of manual.

Note on taking off the battery box!

- | |
|--|
| <ul style="list-style-type: none">● Before you take off the battery box, make sure that the power of the instrument is turned off. Otherwise, the instrument can be damaged. |
|--|

Notes on recharging!

- | |
|---|
| <ul style="list-style-type: none">● The charger has a built-in circuit for protection from overcharge. However, do not leave the charger plugged into the power after recharge is completed, because it will shorten life-span of battery.● Be sure to recharge the battery at a temperature of 0 °C ~ +45 °C. Charge may be abnormal beyond the specified temperature range.● Forbid using any already broken charger and battery. |
|---|

Notes on storage!

- Rechargeable battery can be repeatedly recharged 300-500 times. Complete discharge of the battery may shorten its service life.
- In order to get the maximum service life, be sure to recharge it once per month.
- Do not place the battery in the hot and wet place and never make it short-circuit, or it will mangle battery.

Dispose and recycle battery properly according to local rules. Do not flip it into fire.

2.5 Assemble and Disassemble the Basal Stump

Disassembly

If necessary, the instrument can be removed from the triangle basal stump. First, loosen the triangle basal stump locking screw with a screw-driver. Then, turn the locking button about 180° in counter clockwise and take off the instrument from the triangle basal stump.

Installation

Fit directing convex mark to the directing concave on the tribrach. Put the three fixing feet into the holes respectively. Turn the locking button clockwise about 180° to fix the instrument to tribrach, then tighten the fixing screw of the locking button with a screw driver.

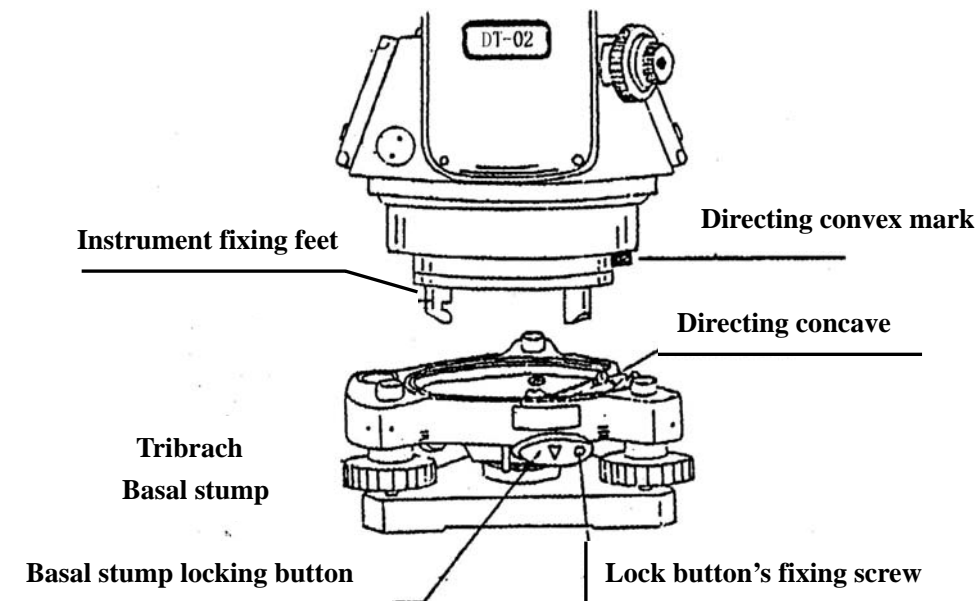

3. KEYBOARD AND PANEL

3.1 Keyboard

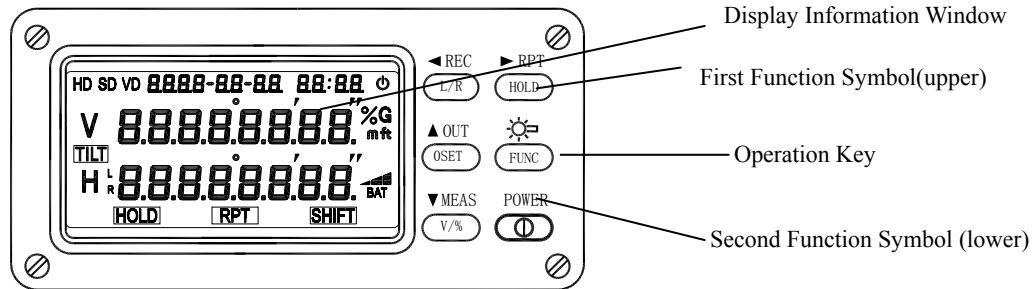

Each key on the keyboard has double functions. Generally, instrument performs the first basic function of press-key. It will carry out the second extended function marked above key after pressing **FUNC**.

<p>(◀) REC L/F</p>	<p>Save key. Press it under shift mode, current angle twinkles twice, and then it is saved in memory. Press it to move cursor to left under special functional mode.</p> <p>Selection key for right or left horizontal angle. Press the key alternately to display two angles accordingly</p>
<p>(▶) RPT HOLD</p>	<p>Repeated measure key. Press to enter repeated state under shift mode. Press it to move cursor to right under special functional mode.</p> <p>The horizontal angle locking key. Press the key twice to lock the horizontal angle. Press the key again to return to unlock.</p>
<p>▲ OUT 0 SET</p>	<p>Export key. Press it under shift mode to export current angle to serial-port and to record with electronic controller. Decreasing key. Press it under special functional mode to move cursor down or decrease number.</p> <p>Horizontal angle “0” setting key. Press it twice to set horizontal angle 0.</p>
<p>▼ MEAS V/%</p>	<p>Distance measure key. Press it under shift mode to make tracking measure once per second and precision is 0.01m (valid to connect with range finder). Press it continuously to display slope distance, horizontal distance, vertical distance and angle alternately.</p> <p>Increasing key. Press it in special functional mode to move cursor moves up or increase number.</p> <p>The shift key between vertical angle and slope percentage.</p>
<p>☀ FUNC</p>	<p>Crosshairs and LCD illuminating key. Press it for 3 seconds to turn on light, and than press it for 3 seconds to turn off.</p> <p>Mode shift key. Press it continuously to enter different mode alternatively performing functions marked on the key or panel respectively. Press it under special functional mode to quit or confirm.</p>
<p>POWER</p>	<p>Power switch. Press the key to turn on; Press the key for over two seconds to turn off.</p>

3.2 Panel

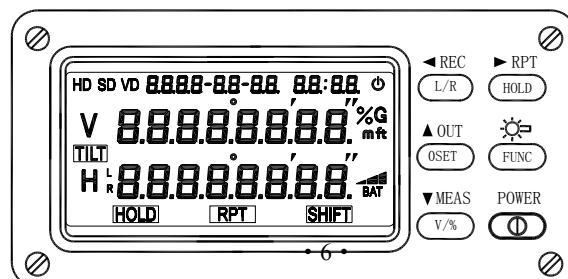

Press-key	Function 1	Function 2
(◀) REC L/F	Increment of right and left horizontal angle.	Save measured data
(▶) RPT HOLD	Hold horizontal angle	measure angle repeatedly
▲ OUT 0SET	Reset horizontal angle	Export measured data through serial-port
☀ FUNC	Select the second function	Illumination for LCD and graduation board
▼ MEAS V/%	Vertical angle/slope angle percentage	Measure slope /horizontal/vertical distance
POWER	Power switch	

3.3 Display Information

Liquid Crystal Display is lined and normal symbols will be displayed in the following figure:
Angle or distance or tip is displayed in the two middle lines with 8 digits. Symbol or character in both right side and left side represents the content or unit of data.

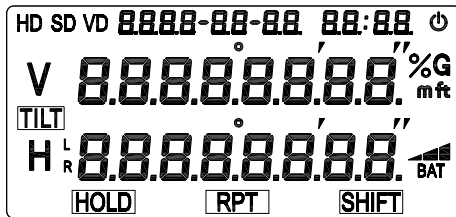

Symbol	Content	Symbol	Content
VA	Vertical angle	%	Slope percentage
HA	Horizontal angle	G	Angle unit: division (Gon)(no symbol if unit is degree and mill)
L(d)	Level dextrorotation increment(clockwise)		
L(l)	Level laevorotatory increment(clockwise)	m	Distance unit: meter
SD	Slope distance	ft	Distance unit: foot
HD	Horizontal distance	BAT	Batter capacity
VD	Vertical distance	L	Lock mode
C	Tilt Compensator	⏻	Automatic close mark
R	Repeat mode	S	Shift to the second function

4. INITIAL SETTING

The instrument has many functions for selection in order to fit needs of result that different jobs require. Therefore, before using the instrument, we have to do initial setting according to different jobs' need.

4.1 Setting Items

- (1) Unit of angle measurement: 360° ,400gon, 6400mil (factory setting:360°).
- (2) Vertical angle zero direction setting: horizontal zero or zenith zero (factory setting: zenith zero)
- (3) Automatic power off function: 30 minutes or 10 minutes (factory setting: 10 minutes).
- (4) Minimum unit of angle displayed: 1" or 5" (factory setting: 1").
- (5)Vertical zero compensation choosing: Auto compensation or uncompensated (factory setting: auto compensation. This item is not available for those instruments that have no compensation with them.)
- (6) Horizontal angle reading passes through the quadrants of 0° , 90° , 180° , 270° with the beeps or no beeps (factory setting: beep).
- (7) Compatible with different kind of EDM. (factory setting **SOUTH ND Series**)
- (8) Current time setting (factory setting: YYYY - MM-DD HH:MM).

4.2 Setting Method

- (1) Press **L/R** to power on and loosen it until hearing three beeps. It enters initial setting mode state, monitor displays:

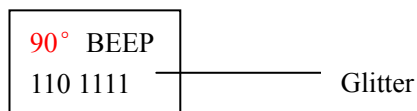

Seven digits in the next line of monitor respectively represent the content of initial setting as follows:

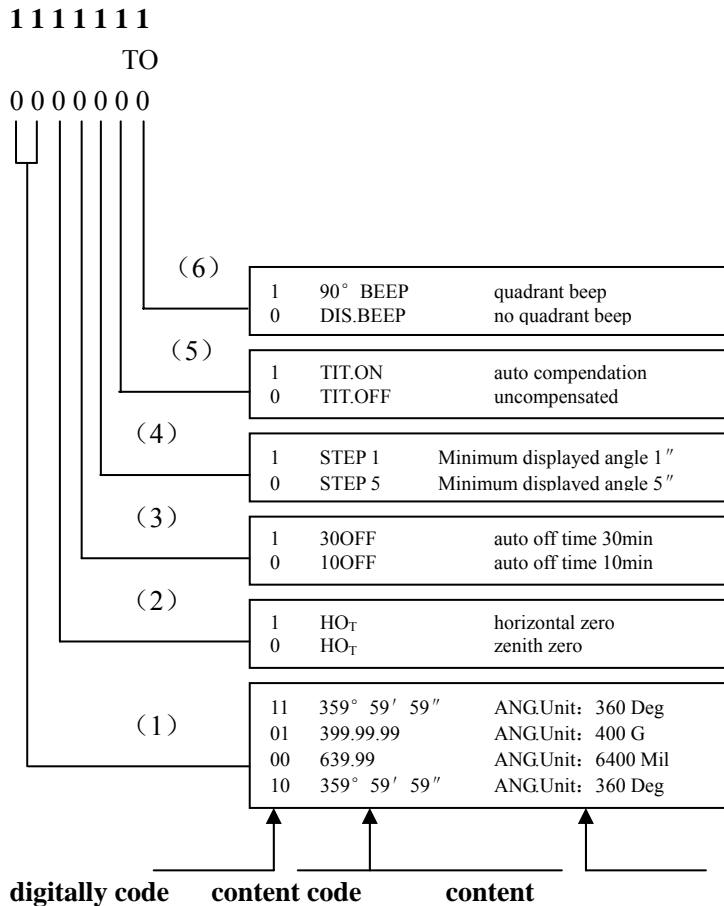

- (2) Press (◀) or (▶) key to move cursor to the figure digit needed to be modified.
- (3) Press ▲ or ▼ key to alter figure which represents content prompting in the form of character and code and displaying in the upper line of the monitor.
- (4) Repeat step (2) and (3) to set other items until all complete.
- (5) Press **FUNC** to confirm after setting, and then it enters the interface of time setting.
- (6) Time format: **Y-M-D H:M** , for example, **2007-01-01 00:00**, then press (◀) or (▶) key to move cursor to the figure digit needed to be modified.
- (7) Press ▲ or ▼ key to alter figure which represents content prompting in the form of character and code and displaying in the upper line of the monitor.
- (8) For example, set time as **2007-01-01 00:00**. Set year as 2007 firstly through ▲ or ▼, the same goes with month, day, hour and minute (note: unnecessary to set second).
- (9) Press **FUNC** to confirm after setting, and save the new time to the instrument.

- After initial settings are finished, the key **FUNC** must be pressed to confirm and save the setting, or the instrument will keep the original setting.
- During long-term usage, it is possible that the battery of real-time clock breaks off or lacks power, which causes a great difference between displayed time and current actual time, moreover, it is inconvenient to set time by the previous method (6) (7) and (8) . (For example, the displayed time is 1234 caused by an unexpected reason and the real time is 2007, it is obvious that setting using former methods will be in trouble.) Here press **L/R** key for over 5s in the time setting interface, then the instrument will automatically initialize time as 2007-01-01 00:00. Reuse the previous approaches to set time on the basis of it.

5. PREPARATION FOR SURVEY

5.1 Centering and Leveling

Setting up the instrument and the tripod

- (1) Adjust the tripod legs to obtain a height suitable for observation when the instrument is set on the tripod.
- (2) Hang a plumb bob on the hook of the tripod, and center over the station on the ground coarsely. At this time, set the tripod and fix the tripod legs firmly into the ground and the plumb bob coincides with the station on the ground.
- (3) Adjust the length of each leg to make the tripod head as level as possible. Fix the lock screws of the tripod legs, then put the instrument on the tripod head and lock with the screws.

Centering and leveling with the optical plummet

- (1) Adjust the three leveling screws to the position where the bubble is in the center of the vial. Look through the optical plummet eyepiece and rotate the eyepiece knob until the reticle can be seen clearly.
- (2) Rotate the focusing knob of the optical plummet until the measurement land mark can be seen clearly and is in the same plane together with the mid-split graduation mark.
- (3) Loosen the center screw of the tripod. Look through the optical plummet, and shift the instrument base on the tripod, taking care to avoid rotating the instrument until the center mark coincides with the station.
- (4) By adjusting any two leveling screws, the bubble is in the center of the vial.
- (5) Observe through the optical plummet whether the land mark coincides with the center of the reticle. If not, repeat the above (3) and (4) steps until they are coincided.
- (6) Make sure that the land mark coincides with the center of the reticle , then lock the instrument.

Caution: do not touch the tripod legs lest altering the position of the instrument.

Leveling precisely with plate vial

- (1) Let the plate vial be in parallel with a line jointing of any two of leveling screws. Adjust these two leveling screws in opposite directions at the same time to the position where the bubble is in the center of the vial.
- (2) Rotate the plate vial 90° around the vertical axis, make sure that the bubble is in the center by adjusting the third screw.
- (3) Rotate the plate vial 90° , repeat(1) and (2) , make sure that the bubble is in the center when plate vial is moved to any directions.
- (4) Rotate the instrument 180° from position (1) . If the bubble is in the center and always in the center while the plate vial is moved to any directions, the plate vial is set correctly and the instrument is leveled.

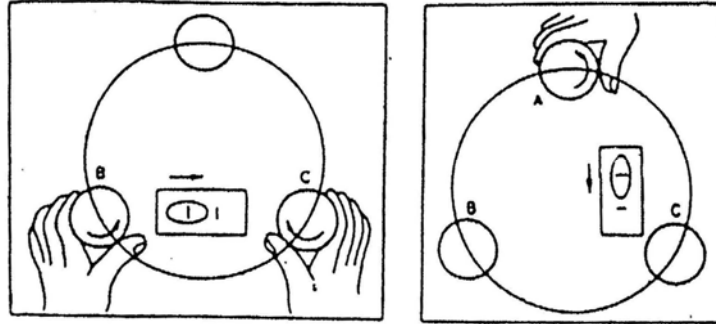

- Notice the relation between the directions of leveling screws' rotation and the bubble shifting direction.
- If the bubble does not remain in center in (4) , “Adjustment of plate vial” is necessary. Refer to chapter (8.1) adjustment method.

5.2 Eyepiece Adjustment and Object Sighting

Eyepiece adjustment

- (1) Remove the telescope lens cover.
- (2) Sight the telescope at the sky and rotate the eyepiece ring until the reticle appears at its clearest state.

- When looking into the eyepiece, avoid an intense look to prevent parallax and eye fatigue. If it is hard to see the reticle due to poor brightness, press (☀) key to illuminate it.



Object Sighting

- (1) Sight the telescope at the object using the collimator.
- (2) Look through the telescope eyepiece and finely adjust the focusing knob until the object is perfectly focused.
- (3) Use the clamp screw, then the tangent screws to sight at the object exactly. If focusing is correct, the reticle will not move, in relation to the object, even when you move your eye slightly left and right.

- **Turn the focusing knob clockwise to focus a near object. Turn the knob counterclockwise to focus a far object.**
- **If do not adjust (3) well , parallax may distort the relation between the object and reticle, resulting in the observation error.**
- **When aligning to an object using the tangent screw, always align by rotating the screw clockwise. If the screw is overturned, turn it back to the original position and sight the object by rotating the screw clockwise again.**
- **Even when vertical angle measurement is not required, it is recommended that the object be placed to the center of the reticle as exact as possible.**

5.3 Power On or Off

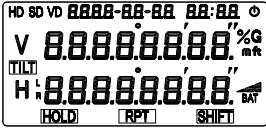
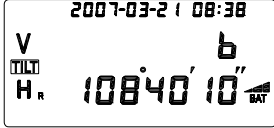
Key style power switch

operation	display
<p>Press [POWER] key and hold it until all the symbols are displayed. The power is on.</p>	
<p>Horizontal angle will be displayed in 2 seconds and then the measurement can be started.</p>	
<p>Press and hold [POWER] key over 2 seconds to turn power off.</p>	

- When the power is turned on, the displayed angle value is the value saved in memory last time. If the displayed angle is no use anymore, do the horizontal zero setting.
- If no operation is performed in 10 or 30 minutes. The power will be turned off automatically due to “power auto off function” and the horizontal angle will be stored in memory automatically.

5.4 Vertical Index Zero Setting (V 0SET)

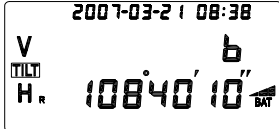
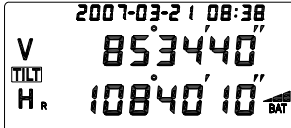
operation	display
<p>Turn on the instrument. Displaying “b” means that the vertical axis is not vertical. If the instrument is leveled exactly, “b” will disappear.</p> <p>After the instrument is leveled exactly, turn on the instrument and it displays “V 0SET” which means that the vertical index has been set to zero.</p> <p>Turn the telescope up and down in normal position in horizontal direction. Vertical index zero is set when the telescope passes level and the vertical angle is displayed. The instrument is now ready for angle measurement.</p>	 

-
- **If vertical index automatic compensation set is used, the vertical index can be compensated. When the vertical index is beyond the designed criterion, “b” will be displayed. Level the instrument precisely until “b” disappears. Then the instrument gets its breath again.**
 - **If no operation is performed in 10 or 30 minutes. The power will be turned off automatically due to “power auto off function” and the horizontal angle will be stored in memory automatically.**

6. BASIC SURVEY

6.1 Observation from Normal/Reversed Position

“Normal position telescope” means that the shaft disc is on the left side of the telescope when observers face eyepiece lens (see figure). “Reversed position telescope” means that the shaft disc is on the right side of the telescope when observers face eyepiece lens. In angle measuring, we should get the measuring result through averaging the two values got from both observations above. And only in this way can the influence caused by the instrument’s systematic errors be eliminated effectively. Therefore, when doing horizontal and vertical observation, rotate telescope 180° to do normal position observation after finishing reversed position observation



Reversed Position Observation

Normal Position Observation

6.2 Horizontal Angle “0” Setting (0 SET)

Sight reticle of the telescope at object A, press **O SET** twice to set the horizontal angle as $0^\circ 00'00''$. For instance, sight at object A displaying \rightarrow HR $50^\circ 10'20''$ \rightarrow press **O SET** twice \rightarrow displaying HR $0^\circ 00'00''$

- [OSET] key is valid only for horizontal angle.
- Horizontal angle can be set to “0” any time except when [HOLD] key is set. If [OSET] is pressed by mistake during operation, there is no effect unless the key is pressed again. When the beep stops, the instrument is ready for next operation.

6.3 Horizontal and Vertical Angle Measurement

(1) Set horizontal angle dextrorotation and vertical angle as zero

Turn the instrument clockwise to sight at the object A exactly, press **OSET** twice to set horizontal angle to $0^\circ 0'00''$ as the initial zero direction. The steps and displaying contents are as follows:

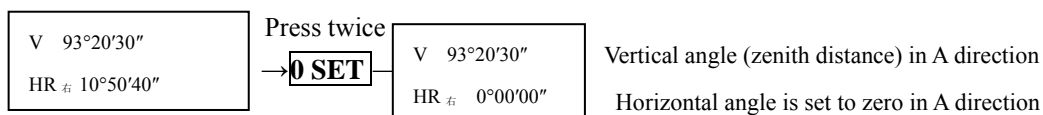

Turn the instrument clockwise and sight at object B, Suppose that:

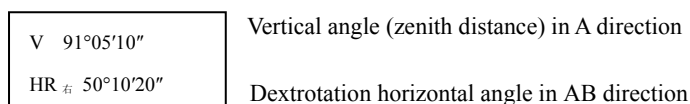

(2) Press R/L to change horizontal angle from right to left mode.

Turn the instrument counterclockwise (HL), sight at the object A exactly, press **OSET** twice to set horizontal angle to 0° 00'00" as the initial zero direction. The steps san displayed results are the same as (1).

Turn the instrument counterclockwise and sight at objects B. The displayed contents are the followings:

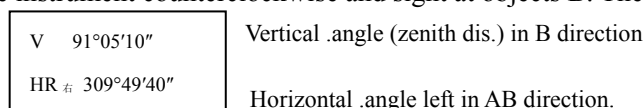

6.4 Lock and Unlock Horizontal Angle (HOLD)

During horizontal angle observation, if you want to retain the measured value, press **[HOLD]** twice. Once horizontal angle is locked, "HRL" is displayed and the horizontal angle value will not change even if you rotate the instrument. When you sight at the needed direction, press **[HOLD]** again to release lock function. Then the horizontal angle value is the original locked value.

- **[HOLD] is invalid for vertical angle or distance.**
- **If [HOLD] key is pressed by mistake during operation, it does not matter unless the key is pressed again. When the beep stops, next operation can be continued.**

6.5 Quadrant Sound of Horizontal Angle Setting

- (1) Sight at the first objective and then press **[O SET]** twice to set the horizontal angle to zero.
- (2) Turn the instrument around the vertical axis about 90° until the beep starts ,displaying HR89° 59'20"
- (3) Lock the instrument by the clamp screw and set the horizontal angle to 90° 00'00" by the tangent screw. Then, fix the quadrant target direction by the telescope reticle.
- (4) determine the quadrant target direction of 180° and 270° using the same method.

- **The beep beeps when the reading passes any of 0° , 90° ,180° ,270° . It beeps in the range of ±1'-- ±20'.**
- **The beep can be canceled in the initial setting.**

6.6 Vertical Angle "0" Setting

Before starting operation, initial setting in vertical angle is doing according to operation's requirement selecting zenith 0/horizontal 0(Refer to 4.2 initial setting.). Vertical disk structures of two settings:

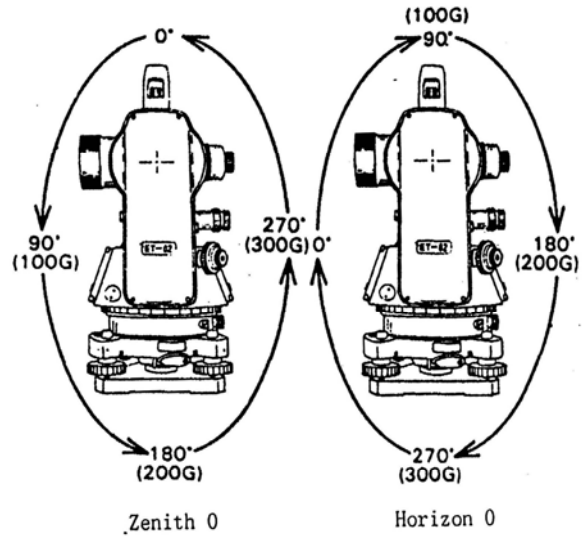

6.7 Measure Zenith Distance and Vertical Angle

(1) Zenith distance: If vertical angle is 0° in zenith direction, then the vertical angle measured in this way is the zenith distance. (shown as the figure)

$$\text{Zenith distance} = (L + 360^\circ - R) / 2$$

$$\text{Index difference} = (L + R - 360^\circ) / 2$$

(2) Vertical angle: If vertical angle is 0° in horizontal direction, then the vertical angle measured in this way is the perpendicular angle. (See the figure).

$$\text{Vertical angle} = (L \pm 180^\circ - R) / 2$$

$$\text{Index difference} = \left(\frac{L + R - 180^\circ}{540^\circ} \right) / 2$$

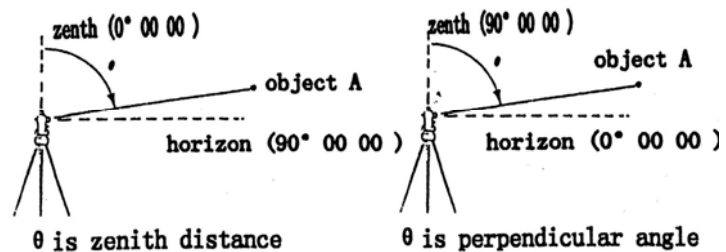

● If the absolute value of index difference is larger than 10'' (i.e. $|I| \geq 10''$), adjustment should be made as introduced in chapter 8.5 and 8.6 in this manual.

6.8 Slope Percentage

The vertical angle can be converted into slope percentage in angle measurement mode. Press V/% and the display shows vertical angle or grade percentage alternately.



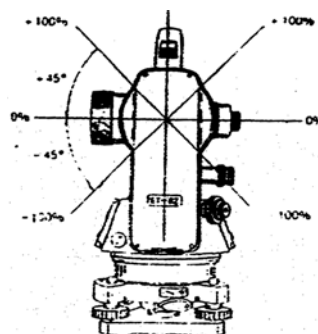
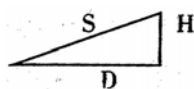



$$\text{Slope \%} = H/D \times 100\%$$

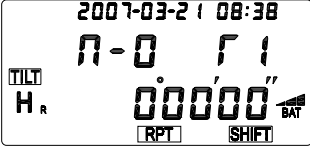

The range of slope percentage should be between the horizon direction and $\pm 45^\circ$ ($\pm 50G$). Otherwise the instrument will display over EEE.EEE%

6.9 Repeat Angle Measure

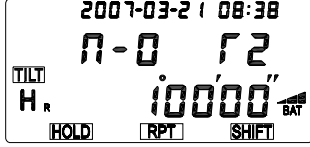
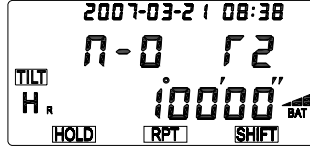
Turn on the instrument in angle measure mode

Operation	Display
<p>① Press FUNC key.</p>	
<p>② Press RPT key to enter repeat measure mode.</p>	
<p>③ Sight at the first target A.</p>	
<p>④ Press L/R key to set the reading of the first target as 0°00'00".</p>	
<p>⑤ Sight at the second target B with horizontal tangent screw and clamp screw.</p>	
<p>⑥ Press HOLD key to hold and save it into the instrument.</p>	
<p>⑦ Sight at the target A again with horizontal tangent screw and clamp screw.</p>	
<p>⑧ Press L/R key to set the first target as 0°00'00".</p>	
<p>⑨ Press HOLD key to hold and save it into the instrument.</p>	
<p>⑩ Press L/R key to set the first target as 0°00'00".</p>	
<p>⑪ Press HOLD key to hold and save it into the instrument.</p>	
<p>⑫ Press L/R key to set the first target as 0°00'00".</p>	
<p>⑬ Press HOLD key to hold and save it into the instrument.</p>	

⑨ Sight at the second target B again with horizontal tangent screw and clamp screw.

⑩ Press **HOLD** key to hold and save it into the instrument.
Average angle appears. Repeat steps ⑥ to ⑩ to do measure with the number you want to.
Press **FUNC** to exit after completion.

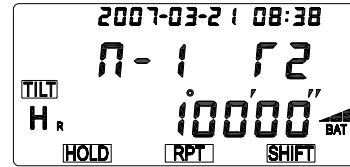
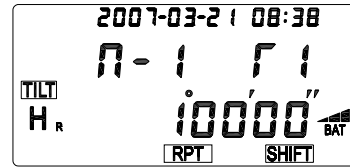
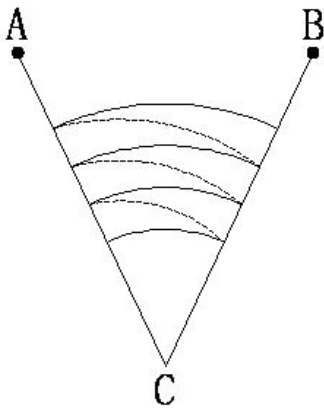

- ※ The number of repeat measure in repeat measure mode is limited to 8. If exceeds 8 times, it will quit automatically.
- ※ Sight at the target and begin with step ③ when doing repeat measure again.
- ※ Press **FUNC** key to quit repeat measure mode and return to angle measure mode.

6.10 Export Angle

Turn on and enter angle measure mode, and press **FUNC** key to enter the second function selection mode. Press **OUT** key to export the current angle to serial-port or electronic controller (baud rate is 1200), “-----” will be displayed on the screen for one second after successful export.

6.11 Save Angle

Turn on and enter angle measure mode, press **FUNC** key to enter the second function selection mode, and then press **REC** to save angle. At that time, the current angle is glittering twice, which represents it has been saved to the memory. If you want to save angle again, press **REC** key after regulating an angle.

If you want to look over saved angle data, please refer to Chapter 7 about memory.

Notice: the instrument only supplies 256 groups of angle data (each group of angle data includes one vertical angle and one horizontal angle). If angle data saved exceeds 256 groups, “FULL” will be displayed on the interface which prompts users that memory is full. Users then need to clear manually to resave angle, please refer to the chapter about memory for more details.

6.12 Measure Distance with Stadia

The distance from the measuring object to the instrument can be obtained by using the stadia hair of the telescope with the accuracy $\leq 0.4\%D$.

- (1) Set up the instrument at point A and put the surveying rod on target point B.
- (2) Read the intercept d of apparent lines from up and down from the reticle on the survey rod.
- (3) The horizontal distance (D) between A and B can be attained with the formula below:

$$D = 100 \times d$$

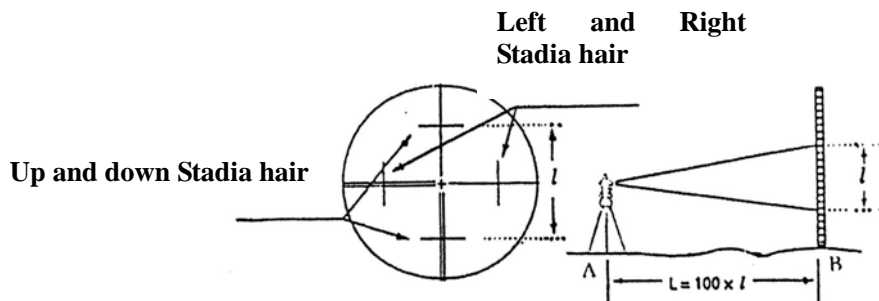

- The precision of this kind of distance measurement is not very high. This method is not used when high precision is required.

7. MEMORY

7.1 Examine Instrument's Serial Number

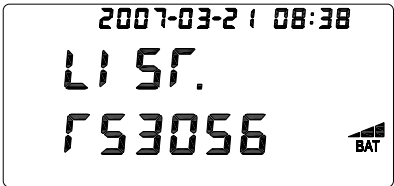
Operation	Display
<p>① Press FUNC key and POWER key to turn on. After beeping three times, it enters memory examining interface. What displayed on the main interface is instrument's serial number that is the same as the number printed on the instrument's body, for instance, T53056, shown as the right picture. Hope users check it carefully to protect their own interests.</p> <p>② Press FUNC to quit.</p>	

7.2 Examine Angle Data in Memory

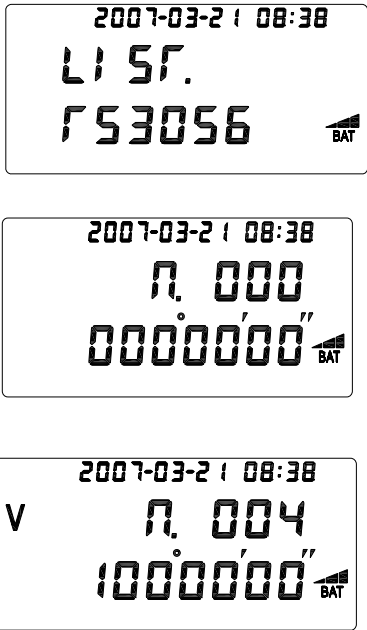
Operation	Display
<p>① Press FUNC key and POWER key to turn on. After beeping three times, it enters memory examining interface.</p> <p>② Press V/% key to display angle data in memory mode. N. 000 means there is no angle data in memory.</p> <p>③ N. 001 means there are angle data in memory, so we can use (◀) and (▶) to select angle in memory to look over. Use ▲ or ▼ to select vertical angle and horizontal angle displayed in the second line. What shown in the right picture is the 4th group of vertical angle data in memory.</p> <p>④ press FUNC to quit and return to examining instrument's serial number. Press FUNC again to quit memory mode and return to angle measure mode.</p>	

7.3 Clear Angle Data in Memory

In the light of steps of examining angle data in memory, press ▼ in examining angle interface for over 5 seconds, it beeps three times, and “CLEAR” appears on the interface, which represents all angle data in memory are cleared.

(Note: memory can save at most 256 groups of data and system will prompt you when storage is full. Then users should transmit useful angle through serial-port and clear data in memory by hand.

7.4 Transmit Data in Memory to Serial-port

In the light of steps of examining angle data in memory, press (◀)(▶) or ▲ ▼ each time to examine angle data in memory which is transmitted through serial-port at the same time. (“-----” suddenly appears in the second line denotes the current angle has been transmitted through serial-port, which can be examined by serial-port facility such as Serial-port Genius. Baud rate is 9600.)

In addition, the function to transmit all angle data to serial-port at a time is furnished. In the light of steps of examining angle data in memory, press ▲ in examining angle interface for over 5 seconds, it beeps three times which means it starts to send all angle data to serial-port. Baud rate is 9600 and sending time depends on the number of angle in memory.

Note: The format of single angle in memory sent to serial-port is “current angle +0x0D+0x0A”.

The format of all angles in memory sent to serial-port is “vertical angle+0x0D+0x0A+ horizontal angle +0x0D+0x0A”.

Angle is sent to serial-port according to chronological sequence, that is, first in first out.

8. CONNECTION WITH CONTROLLER

Connection electronic theodolite with electronic controller

There is a data export and import port that locates at the lower side of optical plummet of ET/DT—02/05/05B electronic theodolite. Transmit measured data to electronic controller for record through connection to electronic controller with cable.

9. INSPECTION AND ADJUSTMENT

9.1 Plate Vial

Inspection

See Chapter 5.1 about “Leveling with Plate Vial”.

Adjustment

- (1) If the bubble of the plate vial drifts away from the center, bring it half excursion back to the center by adjusting the two leveling hand wheels which are parallel to the plate vial.
- (2) Correcting the remaining half by turning the bubble adjusting screw with the adjusting pin.
- (3) Confirm that the bubble does not move away from the center when the instrument is rotated to 180° .
If not, repeat the steps above.
- (4) Turn the instrument by around 90° and adjust the third screw to center the bubble in the vial. Repeat inspection and adjustment steps until the bubble remains in center in any directions.

9.2 Circular Vial

Inspection

It is not necessary to adjust if the bubble of the circular vial is in the center after inspecting and adjusting of the plate vial.

Adjustment

If the bubble of the circular vial is not in the center, bring the bubble to the center by turning adjusting screw with correction pin or adjustable wrench. When adjusting, first loosen the screw on the opposite of the offset direction (1 or 2), then, tighten the adjusting screw in the offset direction to bring the bubble to the center. When the bubble stays in the center, keep the fastening strength of the three screws in uniformity.

9.3 Inclination of Reticle

Inspection

- (1) Level the instrument and select a target A in the line of sight of telescope, sight at A through the center of reticle of graduation board and lock the horizontal and vertical clamp screws.
- (2) Move point A to the edge (point A') of the field of view by rotating the vertical tangent screw.
- (3) No adjustment is necessary if point A moves along the vertical line of the reticle.

If point A' deviates the vertical line of the reticle, that is reticle is tilted, so we need to do correction on graduation board.

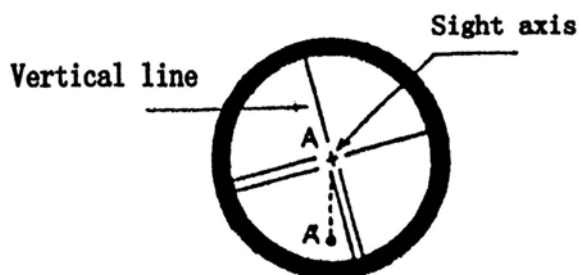

Adjustment

- (1) Firstly, remove the eyepiece cover between eyepiece and focusing screw and you can see four screws.
- (2) Loosen the four reticle adjusting screws equably with a screwdriver. Rotate the reticle around the aiming axis, and align the vertical line of the reticle with point A'.
- (3) Rotate the fastened screw equably. Repeat the inspection and adjustment to see to it that the adjustment is correct.
- (4) Remount the eyepiece cover.

9.4 Perpendicularity of Aiming Axis and Horizontal Axis (2C)

Inspection

- (1) Set an object A at a far distance, the same height as the instrument, level and center the instrument and turn on the power.
- (2) Sight at the object A in normal position and read the horizontal angle value. (Suppose that: $L=10^{\circ}13'10''$).
- (3) Loosen vertical and horizontal clamp screws, and reverse the telescope. Sight at the object A in reversed position and read the horizontal angle value. (Suppose that : $R=190^{\circ}13'40''$)
- (4) $2C = |L - (R \pm 180^{\circ})| = |10^{\circ}13'10'' - (190^{\circ}13'40'' - 180^{\circ})| = 30''30'' \geq 20''$.
That means adjustment is needed.

Adjustment

- (1) To eliminate the big error, use the horizontal tangent screw to adjust the horizontal reading to the correct one: $R+C=190^{\circ}13'40''-15''=190^{\circ}13'25''$.
- (2) Take off the cover of the reticle between eyepiece and focusing screw. Adjust the two adjusting screws by loosening one and tightening the other. Move the reticle to sight at the object A exactly.
- (3) Repeat inspection and adjustment until $|2C| < 20''$.
- (4) Remount the cover of reticle back.

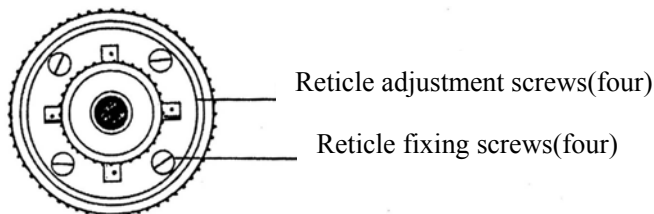

9.5 Automatic Compensation for Vertical Index Difference

Inspection

Liquid condenser automatic compensation set is used for vertical index zeroing compensation. We can check if the function works well by the following method.

- (1) Mount and level the instrument and make the telescope parallel with the line connecting the center of the instrument to any one of the screws. Then, lock the horizontal clamp screw.
- (2) Zero the vertical index after turning on the power. Lock the vertical clamp screw and the instrument displays the vertical angle value.
- (3) Rotate the above screw in a direction slowly to about 10mm circumference. The displayed value will change correspondingly and then disappear and display the message "b". The vertical axis inclines more than 3' at this time and exceeds the designed compensation range. When you rotate the above screw

reversely to the original position, the instrument displays the vertical angle again which means that the vertical index difference compensation function works well. (Experiment repeatedly and observe its change at critical position.)

Adjustment

If the compensation does not work well, send the instrument back to factory for repairment.

- **05B model instrument does not have vertical zero automatic compensation set.**

9.6 Vertical Index Difference (I Angle) and Set Vertical Index Zero

After making adjustments as described in 8-3 and 8-5, make the inspection as follows:

Inspection

- (1) Set up the instrument and turn on. Sight at a reference A and obtain the vertical angle (Left).
- (2) Reverse the telescope and sight at the object A again and obtain the vertical angle (Right).
- (3) If vertical angle is zero at zenith, then, $I=(L+R-360^\circ)/2$; If vertical angle is zero at horizon, then, $I=(L+R-180^\circ)/2$ or $(L+R-540^\circ)/2$.
- (4) If $|i| \geq 10''$, vertical index zeroing should be set again.

Adjustment (Setting up vertical index zeroing)

- (1) After leveling the instrument, press **0SET** to turn on and hold it until three beeps. The instrument displays that:

V 90° 20' 30"
C SET -- 1

- (2) In normal position, turn the telescope around near the horizontal direction until vertical angle appears. Sight at a clear and stable objective A, which is nearly the same height as the instrument. Press **0SET** key, displaying:

V 90° 20' 30"
C SET -- 2

- (3) Reverse the telescope and sight at the object A again. Press **0SET** key to finish vertical index zeroing setting. The instrument returns to angle measurement mode.
- (4) Repeat the inspection procedures. If $|I| \geq 10''$, check if anything is wrong in operation and repeat the adjustment again.
- (5) If the vertical index difference does not meet the standard yet after being adjusted repeatedly, the instrument should be sent to factory to be repaired.

- **The vertical angle displayed in the process of zeroing setting is not compensated and corrected, so it can not be used formally but as a reference value.**

9.7 Optical Plummet

Inspection

- (1) Set the instrument on the tripod, and place a piece of white paper with a cross on the ground right under the instrument.
- (2) Adjust the optical plummet focus, and move the center of the crosshairs drawn on the paper to the center of the field of view.
- (3) Adjust the leveling screws to make the center mark of the optical plummet coincide with the intersecting point of the reticle.
- (4) Rotate the instrument around the vertical axis at every 90° and observe that whether the center mark position coincides with the intersecting point of the reticle.
- (5) If the center mark always coincides with intersecting point when rotating the instrument, no adjustment is necessary. Otherwise, the following adjustment is needed.

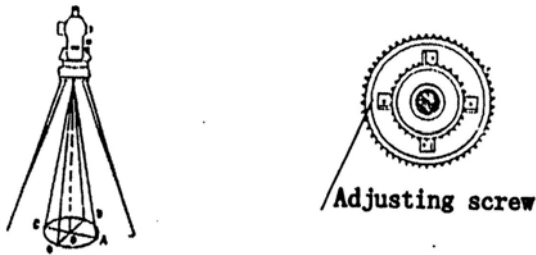

Adjustment

- (1) Take off the protecting cover between the optical plummet eyepiece and focusing knob.
- (2) On the white paper with a crosshairs, mark the place of the center mark when the instrument moves at every 90° , and mark them A,B,C,D respectively.
- (3) Join the diagonals with lines (A, C and B, D).The intersecting point of the two lines is called "0".
- (4) Adjust the four correction screws of the optical plummet by an adjusting pin until the center mark coincides with the smaller circle "o".
- (5) Repeat the above inspecting and adjusting steps until it is up to the requirement.
- (6) Remount the protecting cover.

9.8 Other Adjustment

If the leveling screw looses, adjust it with two correction screws on the basal plate. Tighten the screws till they are fit.

10. SPECIFICATIONS

Telescope	
Image	Erect image
Magnification	30X
Effective aperture	45mm
Resolution	3"
Field of view	1°30'
Shortest stadia	1.4m
Stadia multiplication constant	100
Stadia additive constant	0
Stadia precision	≤0.40%L
Tube length	157mm
Angle measurement	
Angle measurement mode	Absolute encoding mode
Diameter of raster disks (vertical and horizontal)	79mm
Minimum display reading	1" or 5", optional
Detection mode	Horizontal angle: dual
	Vertical angle : dual
Angle measurement Unit	360°/ 400gon/6400mil, optional
Precision	DT-02: 2", DT -05/05B: 5"
Leveling vials	
Plate vial	30"/2mm
Circular vial	8"/2mm
Vertical compensator (05B mode without this item)	
System	liquid condenser mode, optional
Working range	±3'
Precision	±3"
Optical plummet	
Image	Erect image
Magnification	3X
Focusing range	0.5~∞
Field of view	5°
Display	
Type	LCD, double lines, line segment
Data input/output	
Interface	RS --232C
On-board battery	
Power source	Rechargeable NI-H Battery
Voltage	DC 4.8V
Continuous working hours	8h
Working environment	
Working Temperature	-20°~+45°
Dimensions and weight	

Overall dimensions	160X150X330mm
Instrument weight	5.2kg

11. COMMON MISTAKE

When operating the instrument improperly or circuit within the equipment has problems, error codes will be displayed on the screen, whose contents and solving methods are listed as follows:

ErrorCode	Meaning and Solution
Err 01	Something wrong with horizontal disk measurement. Turn off the instrument ,then power on,if Err01still appears,send it to be repaired.
Err 02	Telescope is rotated too fast.Press V/% , after displaying “V 0SET”, show vertical disk index Returnre to 0(namely rotate telescope up and down near the horizontal position when left disk).
Err 03	Collimator is rotated too fast.Press 0 SET to reset.
Err 04	Something wrong with vertical photo-electric convertor (I). Send it to be repaired.
Err 05	Something wrong with horizontal photo-electric convertor (I). Send it to be repaired.
Err 06	Something wrong with horizontal photo-electric convertor (II). Send it to be repaired.
Err 07	Something wrong with vertical photo-electric convertor (II). Send it to be repaired.
Err 08	Something wrong with vertical disk. Turn off and level the instrument. If Err 08 still appears after power on, send it to be repaired.
Err 20	Something wrong with 0set of vertical disk index. Operate again according to chapter 8.6. If Err 20 still appears, press HOLD 、 0SET 、 HOLD to force setting.
Err 21	Exceeded zero-point of electronic compensator of vertical angle. Turn off and level the instrument. If Err 21 still appears after power on, send it to be repaired.

- **When errors appear, check the instrument and your operation steps. If you confirm that something is wrong with the instrument, send it to factory to be repaired.**

12. ACCESSORIES

Standard Configuration

● Packing Case	1
● Mainframe(including a battery)	1
● Charger	1
● AA Battery Box	1
● Plumb	1
● Correction Pin	2
● Soft Brush	1
● Screwdriver	1
● Inner Hexad Wrench	2
● Floss Cloth	1
● Dryer	1
● Certificate of approval	1
● Operation Manual	1

Optional Configuration

● Boluo Board	1
● Syphon Eyepiece	1
● Sunglass	1

After-sales Service Tel: (86)010—67806695

Technical Support Tel: (86)010—67806697